



# SL skirting trunking and RAUDUO electrical/heating trunking

The optimum solution for electrical installations in living spaces

# SL/SL-L/SL-T skirting trunking

For flexible electrical installations

## Trunking for living spaces with added value

The practical modular design ensures huge time savings during mounting, ensuring uncomplicated cable routing. The matched system components provide a flexible and individual electrical supply. The device tanks are installed at any point in the trunking, in the style of a construction kit – this means that the trunking system brings to an end the problem of "cable spaghetti", because sockets and connections for telephones, audio and PCs can be located exactly where they are required.

The skirting trunking is available in three different dimensions, with which the trunking can be adapted to any room. The simple SL skirting trunking is suitable for installation at floor height. The SL-L skirting trunking with sealing lip is ideal for application on uneven walls. Here, the sealing lips compensate for any uneven walls and floors. By contrast, carpeted floor covering can be integrated in the SL-T skirting trunking, meaning that the trunking can be adapted perfectly to the flooring, and thus blend discreetly into the room.





With the SL-L, the sealing lip is suitable for existing buildings for close-fitting wall and floor connections

- Flattened bracket
- Perfect adaptation
- Tapered lip end
- Soft material
- Flawless sealing
- 6 mm lip width
- Depth compensation up to 5 mm
- No ingress of dirt
- Practical supply using vertical triangular trunking

Testing	VDE DIN EN 50085-1, VDE DIN EN 50085-2-1
Delivery form	Cover and base in the box Base with base perforation Fittings and device tanks in the box
Stock length	2 m
Delivery colours	RAL 9001 cream white RAL 9010 pure white 7035 light grey (only REHAU SL range) Small deviations from the RAL colours may occur due to production
Material	Profiles: PVC 1309, self-extinguishing, classified according to UL94: V-0 Fittings and device tanks: PVC-U, self-extinguishing, combustion behaviour according to UL94: V-0
Dimension	Trunking height: 20 mm Trunking width: 50, 70 and 110 mm

# System overview

**For all applications in single or multiple-occupier dwellings, whether a new building or renovation:**

- The product range comprises the dimensions 20 x 50 mm, 20 x 70 mm and 20 x 110 mm
- Connection solutions for all standard devices in support ring and support clamp design
- Length of the standard profiles 2 m
- Versions available in RAL 9010 (trunking width: 50, 70 and 110 mm)
- Matching accessories to maintain the protection classes

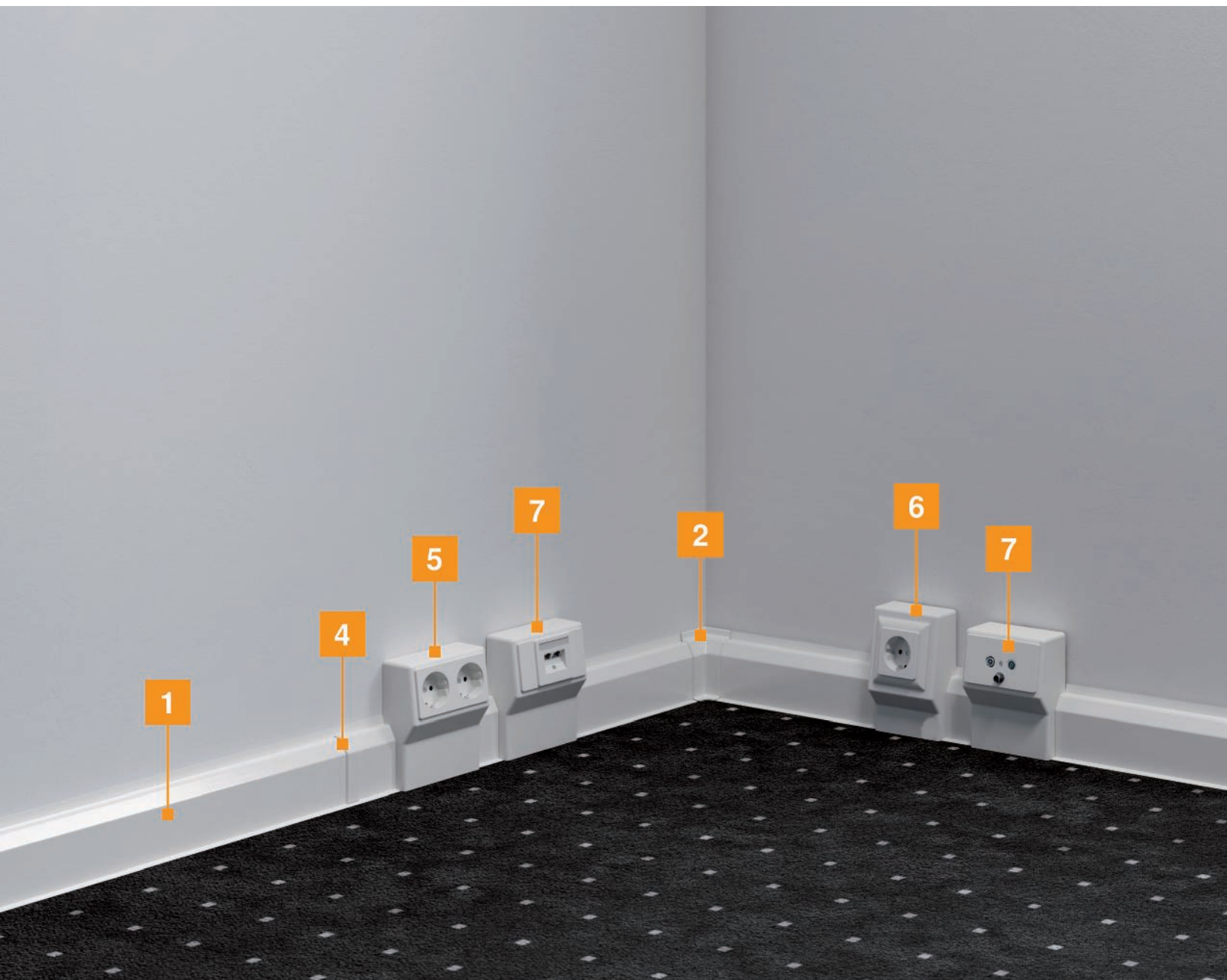





1	Trunking
2	Internal corner
3	External corner
4	Cover coupling
5	Device support with integrated double socket
6	Device support, empty, for standard devices of support ring design
7	Device support, including panel, for the installation of central plate devices according to DIN 49075, with support clamp



06 LFS Elektro-/Heizungskanal RAUDUO / en / 2021/04/14 11:13:17 11:13:17 (LExport\_02886) /

# Classification according to DIN EN 50085-2-1

The systems possess integrated partitions, thus allowing the installation of cables of different voltage levels. With trunking widths of 50, 70 and 110 mm and a height of 20 mm, the system is hardly distinguishable visually from a normal skirting board.

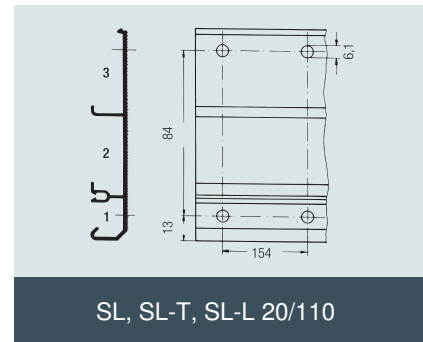
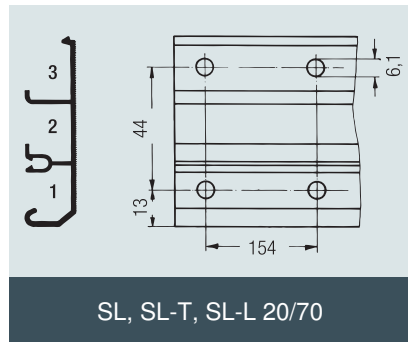
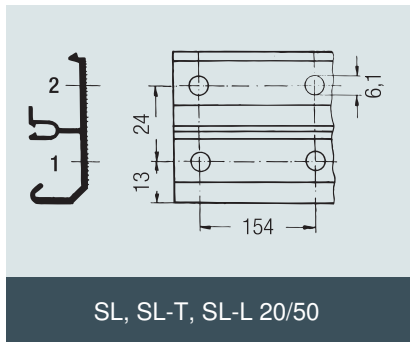

## Connection solution for the installation of standard devices

Structure of a device support:

- Device support for screwing to a wall
- Front plate to be clipped on
- Side adapter plate at the height of the skirting board; cover (only for DIN connections)



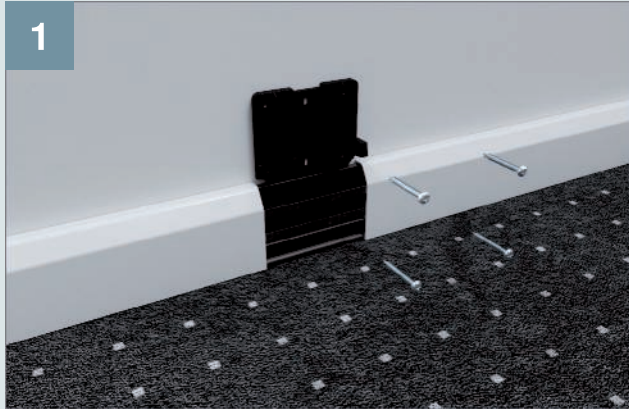

1

Apply the device support to the top of the base and screw to the wall.



2

Connect and screw on the holder.

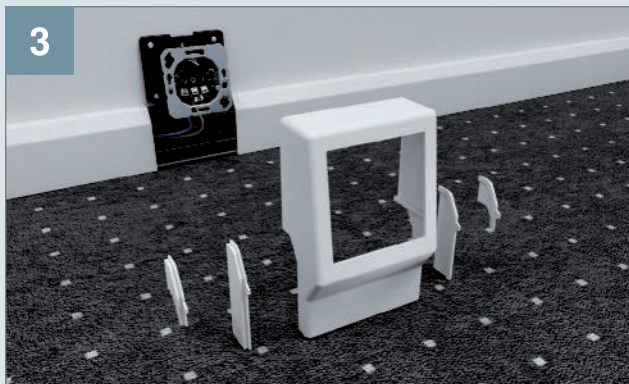

3

Select the adapter plate according to the height of the skirting board. No adapter plate is available for SL 20 x 110.



4

Clip the front plate onto the cover.



5

Mount the connection cover.





# Mounting of SL device tank with double socket

1

With the 50 mm trunking height, apply the device support to the mounted skirting board base in such a way that the two bars serve as spacers. Then, drill the hole and screw to the wall (image without mounted socket base).



2

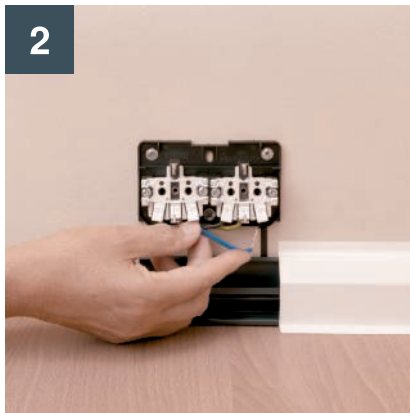

Connect the device support.

3

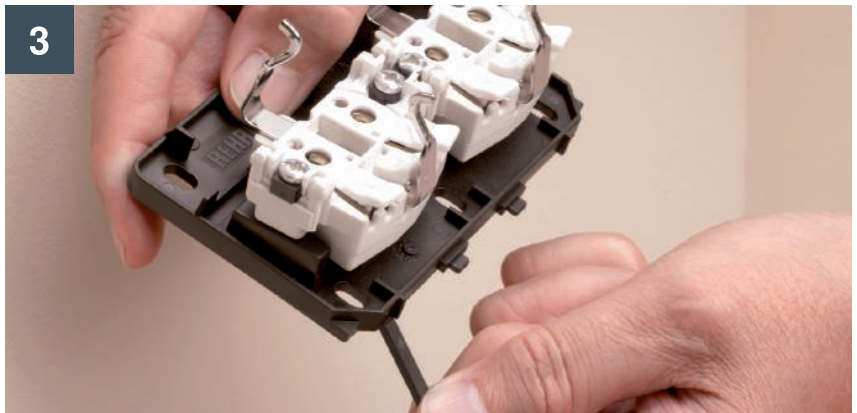

When using the 70 mm-high SL trunking, break out the two bars (spacer).

4

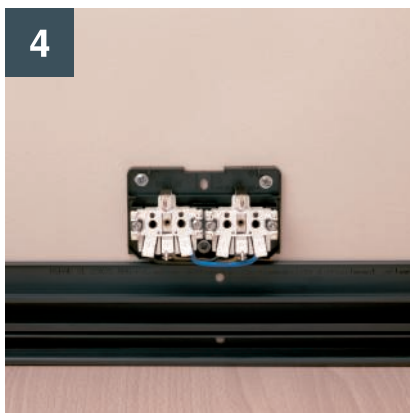

Place the device support directly on the base.

5



When using the 50 mm-high SL trunking, the supplied adapter plate must be engaged on both sides before mounting the device tank.



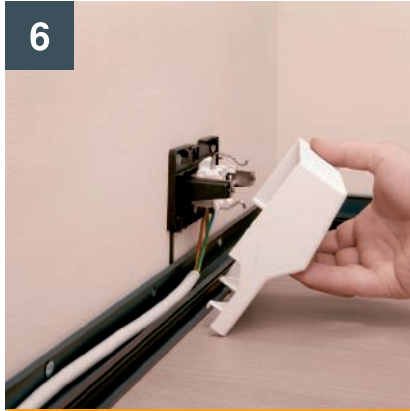

6

Hang the device tank in the SL base.



7

Place the device panel, including the screw, in the opening of the device tank and screw it tight.



8

After mounting, an electrical test must be performed by an authorised electrical specialist.



9

When mounted at the end of a skirting board, the side opening of the device tank is closed off with the side closure – part to be ordered separately.

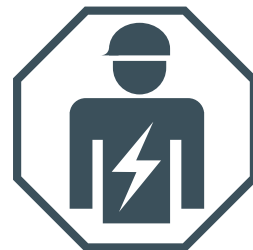

Installation  
electrotechnical expertise

# Installation options

## Individual devices, empty (SL/SL-T/SL-L)

This device tank is suitable for the installation of support ring devices with a 60 mm fastening spacing from all manufacturers.

TAE connection sockets

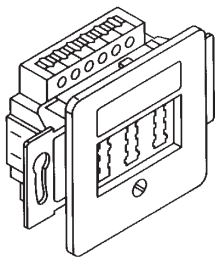

TAE 2 x 6/6 NFF

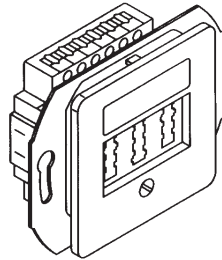

TAE 3 x 6 NFF

UAE connection sockets

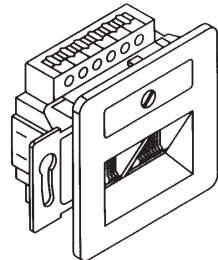

UAE 8/8

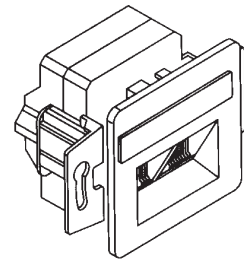

UAE 8/8 Cat 6

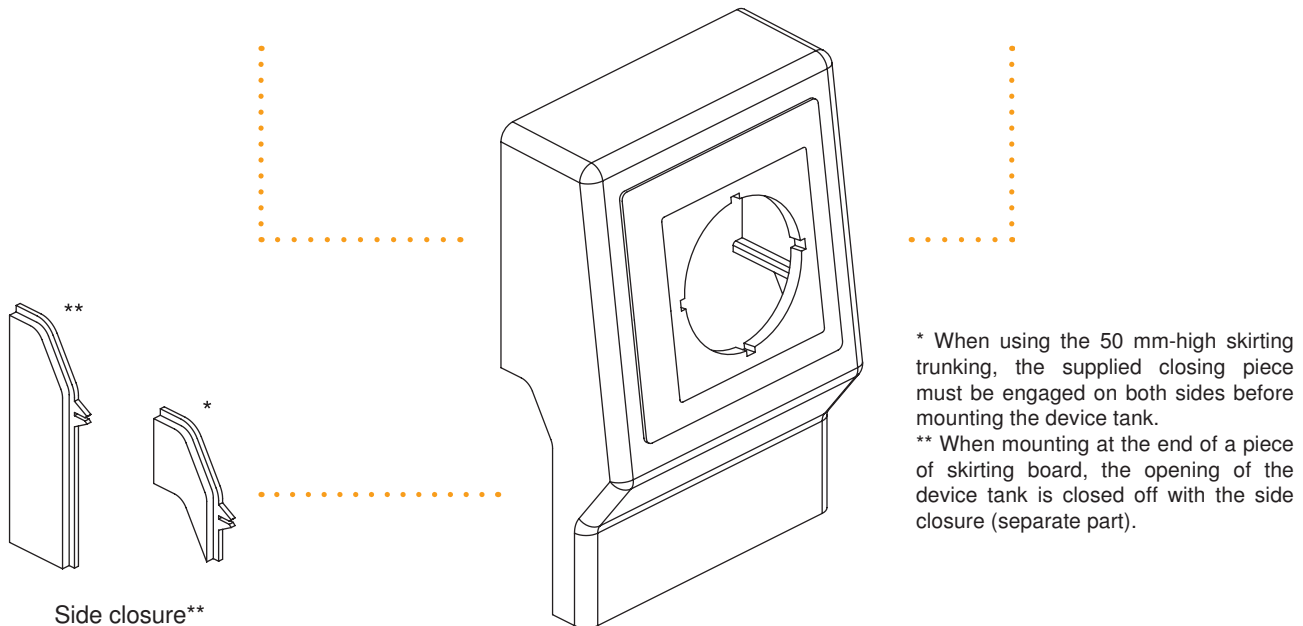

\* When using the 50 mm-high skirting trunking, the supplied closing piece must be engaged on both sides before mounting the device tank.

\*\* When mounting at the end of a piece of skirting board, the opening of the device tank is closed off with the side closure (separate part).

Side closure\*\*

Device tank, empty, incl. panel (DIN 49075)

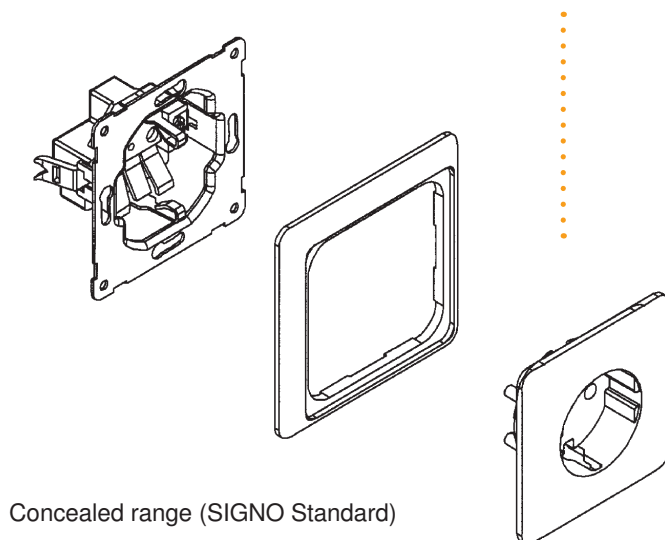

Concealed range (SIGNO Standard)

# Installation options

## Device tank, empty (SL/SL-T/SL-L)

This device tank is suitable for the installation of support clamp devices with 60 mm fastening spacing from all manufacturers.

UAE connection sockets

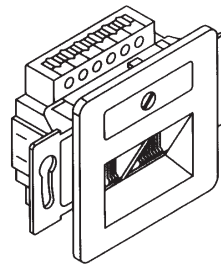

UAE 8/8

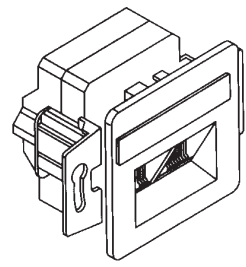

UAE 8/8 Cat 6

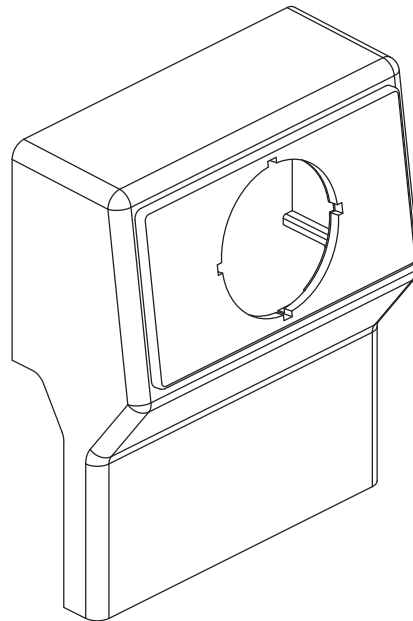
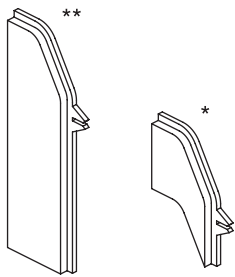

\* When using the 50 mm-high skirting trunking, the supplied closing piece must be engaged on both sides before mounting the device tank.

\*\* When mounting at the end of a piece of skirting board, the opening of the device tank is closed off with the side closure (separate part).

Device tank, empty, incl. panel (DIN 49075)

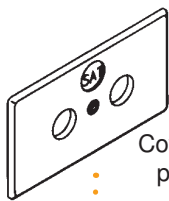

Cover for antenna construction (with predetermined breakout point for SAT)

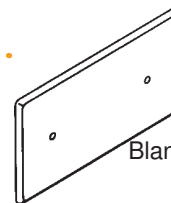

Blanking cover (use as clamping socket)

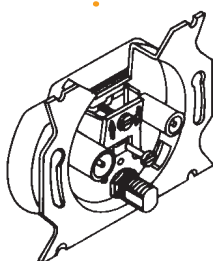

Socket for SAT and BK



# Technical data SL, SL-T, SL-L

## Cable capacity

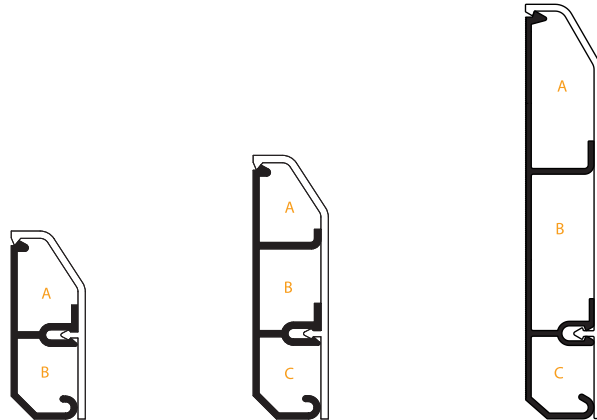

Dimensions	20 x 50		20 x 70			20 x 110		
Number of compartments	A	B	A	B	C	A	B	C
Clear cross-section in mm <sup>2</sup>	290	290	218	314	288	158	614	177
Maximum cable diameter in mm	16	13.5	1.3	13.5	13.5	13	14	14

## Classification according to DIN EN 50085-2-1

Resistant to knocks during installation and use	1 J
Minimum temperature for transport and storage	-25 °C
Minimum temperature for installation and use	-5 °C
Maximum use temperature	+60 °C
Fire resistance	Fire-retardant
Current passage	Without current passage
Insulation	Electrically insulating
Protection level of the housing	IP40
Type of opening	With tool
Terms of use	On the wall Fastening on the wall and support on the floor Fastening on the wall and support on a horizontal surface
Available functions	Type 3
Nominal voltage	500 V
Mechanical resistance	IK06



# RAUDUO combined electrical/heating trunking

## 2 in 1: The risk-free refurbishment idea

The RAUDUO combined electrical and heating trunking is a perfect refurbishment idea for the safe, standardised routing of electrical and heating cables in shared skirting trunking. A thermal buffer ensures functional, tested heat insulation. The test report of the VDE proves that, even at high flow temperatures in the heating pipes, the temperatures in the installation areas for electrical cables remain below 30 °C (despite the cables' intrinsic heat) and thus that no problems occur under normal current loads (DIN VDE 0298 Part 4). In addition, the temperature development at the connection terminals of the protective contact

sockets in the device tank has been tested (DIN VDE 0260, 4.4.1) and behaves in a non-critical manner. For this reason, the VDE report does not require adaptation of the cable system. Normal NYM cables are routed – no special solutions or materials are required. Thanks to the 2-in-1 solution, heating pipes and electrical cables are routed simply in a shared trunking base. The device tanks can be installed at any point in the trunking similar to a construction kit.

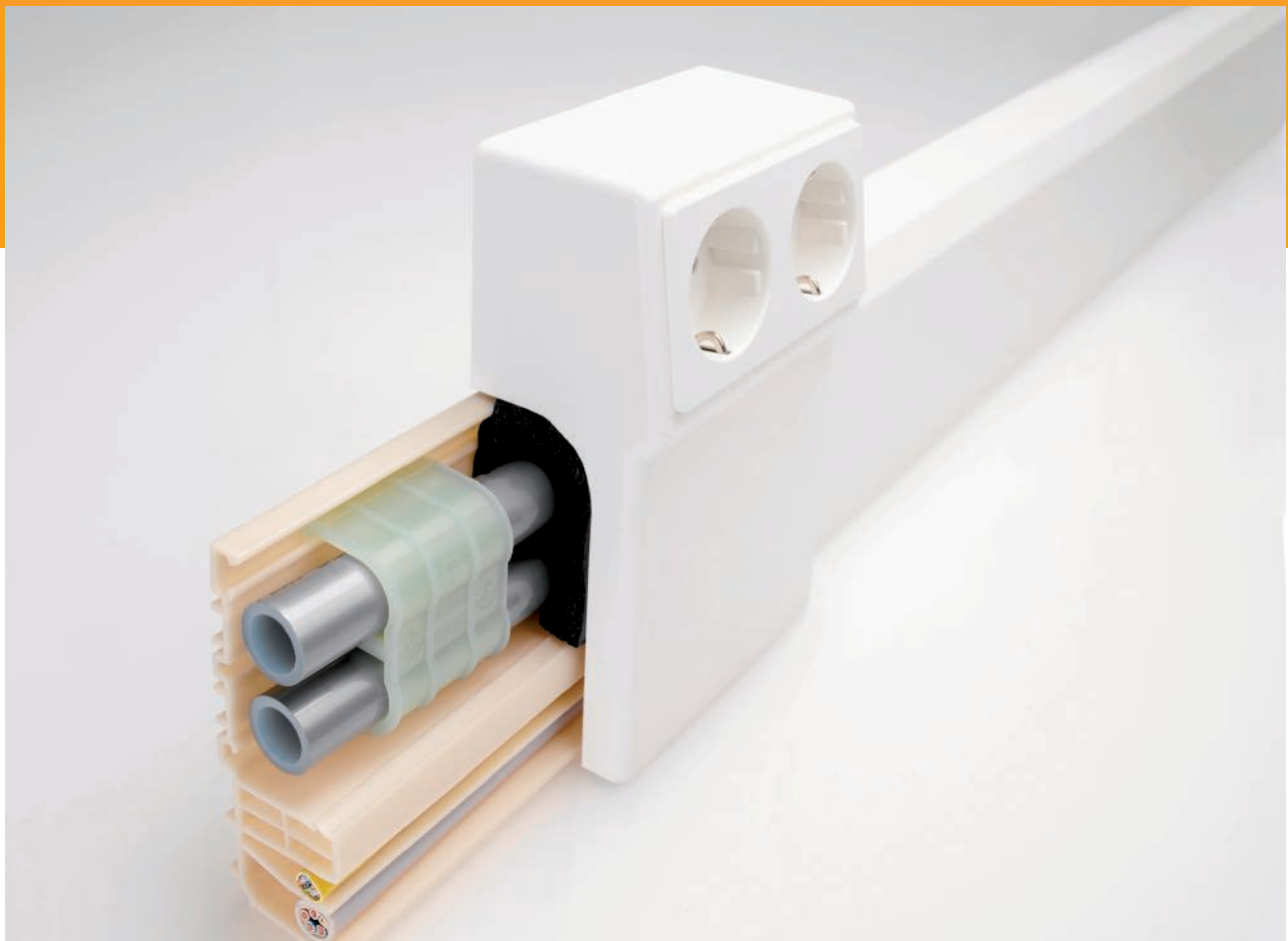





Optionally with sealing lip for existing buildings for an exact wall and floor connection:

- Flattened bracket
- Perfect adaptation
- Tapered lip end
- Soft material
- Flawless sealing
- 6 mm lip width
- Depth compensation up to 5 mm
- No ingress of dirt

Testing	VDE DIN EN 50085-1, VDE DIN EN 50085-2-1, VDE information test regarding temperature behaviour (VDE 0298 Part 4)
Delivery form	Cover and base separately Base with base perforation Fittings and device tanks in the box
Stock length	2 m
Delivery colours	RAL 9001 cream white RAL 9010 pure white Small deviations from the RAL colours may occur due to production
Material	Profiles: Cover and base made of PVC 1309, lead-free, self-extinguishing, classified according to UL94: V-0 Fittings and device tanks: PVC-U, self-extinguishing, combustion behaviour according to UL94: V-0
Dimension	Trunking height: 40 mm Trunking width: 105 mm

# System overview

## Base perforation

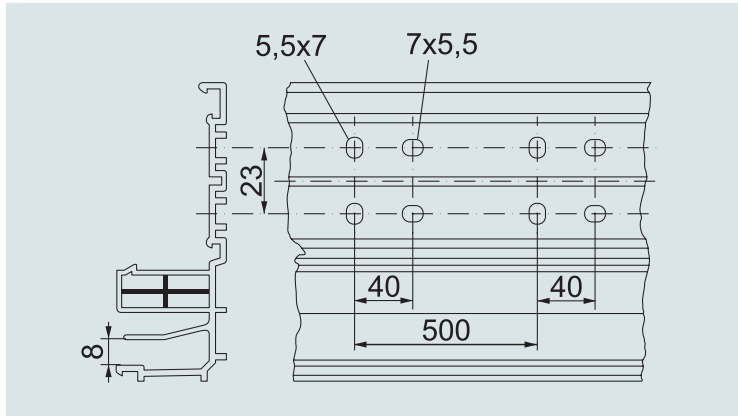

Cross-section | RAUDUO base with base perforation 40/105

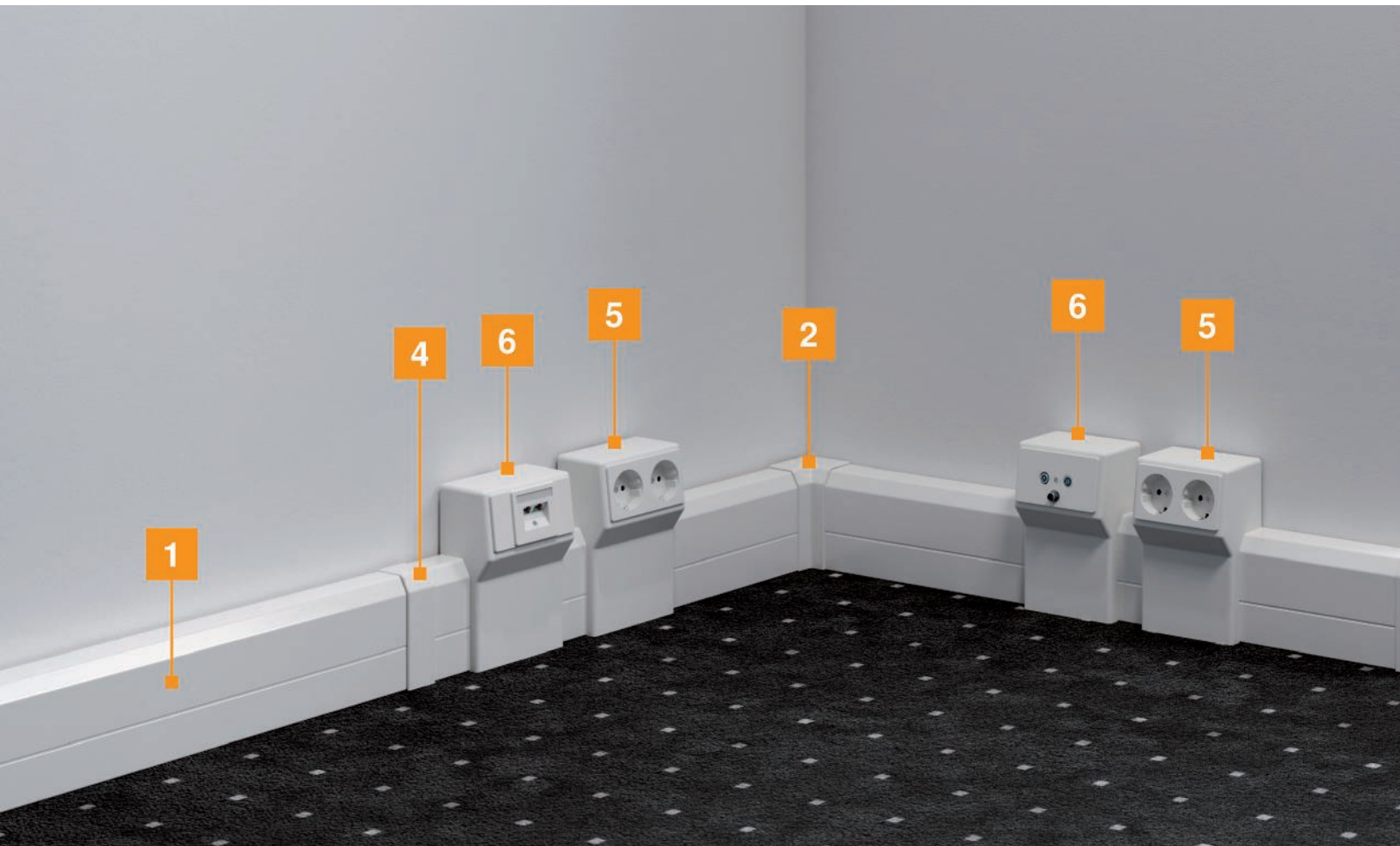

**Bases:**

The base perforation (slots) simplifies mounting

**Covers:**

Either with or without sealing lip.

**Heating pipes:**

Suitable up to 20 mm external diameter. Fastening through the heating pipe support, which is engaged in the base.

**Internal/external corners:**

The bases must be given mitre cuts to exclude heat being drawn away (from the heating chamber into the electrical chamber). In the case of poor structural conditions (uneven walls, etc.), we recommend closing off any gap that may appear when separating the chambers with silicone.

**End pieces:**

Adhesion must take place for VDE-compliant mounting.

**Heating temperatures:**

The RAUDUO system is designed for a flow temperature of 70 °C and a return temperature of 55 °C (according to the VDE information report). With a flow temperature of up to 90 °C and a return temperature of up to 70 °C, the VDE report requires the device tank insulation to be replaced with "90 °C insulation foam", item no. 6132175.



1	Trunking
2	Internal corner
3	External corner
4	Cover coupling
5	Device support with integrated double socket
6	Device support, including panel, for the installation of central plate devices according to DIN 49075, with support clamp



# Installation options RAUDUO device tank

UAE connection sockets

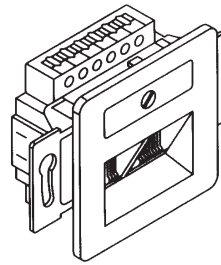

UAE 8/8

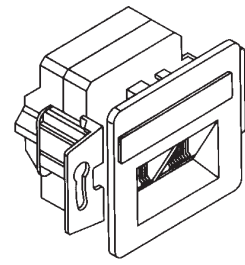

UAE 8/8 Cat 6

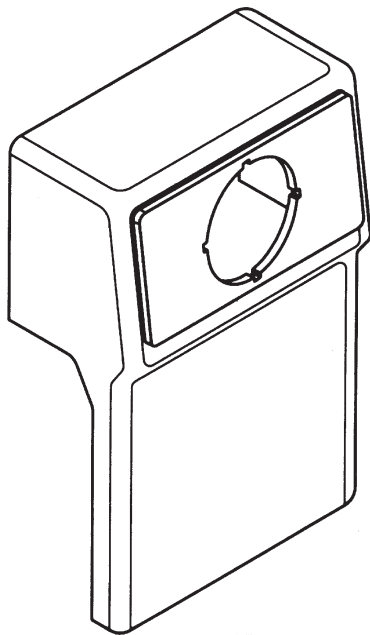

Device tank, empty, incl. panel (DIN 49075)

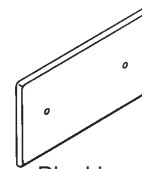
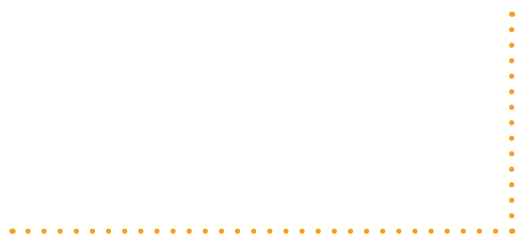

Blanking cover (use as clamping socket)

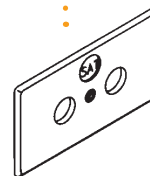

Cover for antenna construction (with predetermined breakout point for SAT)

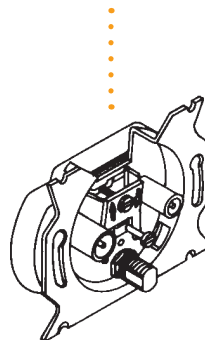

Socket for SAT and BK

**i** Note: The supplied panel is suitable for devices according to DIN 49075 with support bars/brackets.

# Mounting of RAUDUO device tank with double socket

## Mounting steps

1

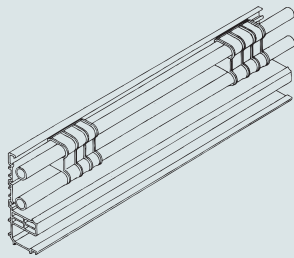

**Mounting requirement**  
a) Mounted trunking base  
b) Installed heating system

2

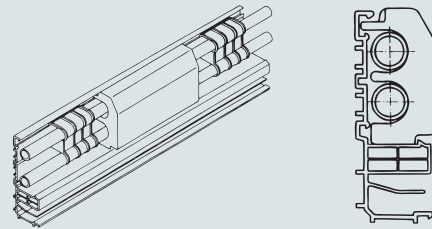

Insert the device tank insulation in the trunking base (at flow temperatures over 70 °C, the solid foam variant, item no. 6132175 must be used!).

3

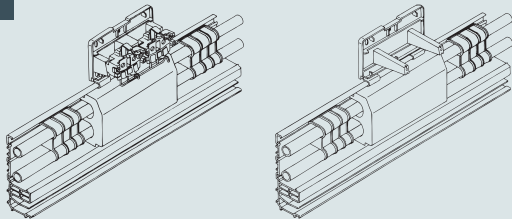

Position the device tank (centrally to the insulation). Then, draw on the drill holes, drill the holes and screw the device support tight.

4

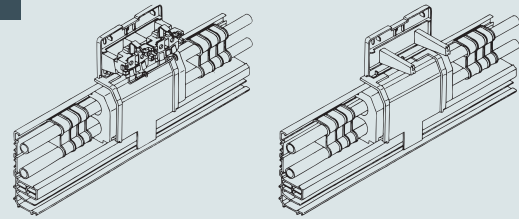

Engage the potential separation plate in the trunking base. The insulation must protrude evenly on the left and the right.

5

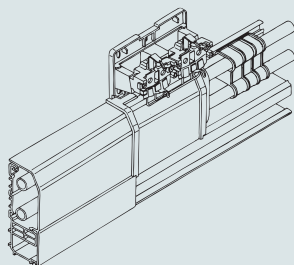

Place the cables separately in the clamps and connect the socket and other connection devices. Close both trunking chambers (electrical and heating chambers) using the shared cover. The trunking covers about the grooves of the potential separation plate on the right and left.

6

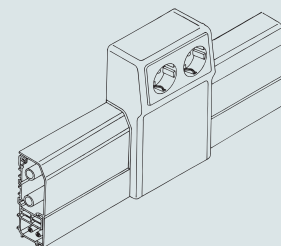

Mount the device tank with cover on the base and close with the cover.

## Skirting trunking SL 2050



Type	Colour	Length mm	Width mm	Height mm	Pack m	Weight kg/100 m	Item no.
SL 2050 rws	Pure white	2000	50	20	42	40.295	6132193
SL 2050 cws	Cream	2000	50	20	42	40.290	6132201

SL skirting trunking for covered cable routing in internal areas. The colour of the trunking bases can vary depending on the production method.

With snap-on cover and base, with base perforation for direct wall mounting. Change the direction with the fittings and close the trunking ends with end pieces. Service outlet for mounting power and data technology.

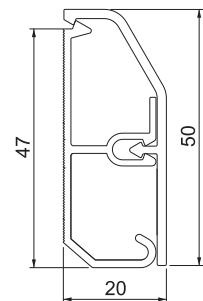

## External corner SL AE2050

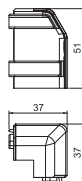

Type	Colour	Length mm	Width mm	Height mm	Pack Piece	Weight kg/100 pc.	Item no.
SL AE2050 rws	Pure white	37	37	51	10	0.900	6132265
SL AE2050 cws	Cream	37	37	51	10	0.900	6132266

External corner as a fitting for changing the direction of the skirting trunking. External corner for snapping on to the base to conceal cuts.

## Internal corner SL IE2050

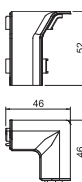

Type	Colour	Length mm	Width mm	Height mm	Pack Piece	Weight kg/100 pc.	Item no.
SL IE2050 rws	Pure white	46	46	52	10	0.400	6132248
SL IE2050 cws	Cream	46	46	52	10	0.400	6132249

Internal corner as a fitting for changing the direction of the skirting trunking. Internal corner for snapping on to the base to conceal cuts.

PVC

### End piece SL ESli2050

Type	Colour	Length mm	Width mm	Height mm	Pack Piece	Weight kg/100 pc.	Item no.
SL ESli2050 rws	Pure white	22	18	52	10	0.500	6132293
SL ESli2050 cws	Cream	22	18	52	10	0.500	6132294



End piece (left) as a fitting for the skirting trunking.  
For a clean end to the trunking system. For attaching to the trunking ends.



PVC

### End piece SL ESre2050

Type	Colour	Length mm	Width mm	Height mm	Pack Piece	Weight kg/100 pc.	Item no.
SL ESre2050 rws	Pure white	22	18	52	10	0.500	6132277
SL ESre2050 cws	Cream	22	18	52	10	0.500	6132278

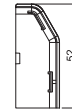

End piece (right) as a fitting for the skirting trunking.  
For a clean end to the trunking system. For attaching to the trunking ends.



PVC

### Skirting trunking SLL 2050



SL-L skirting trunking for covered cable routing in internal areas. The colour of the trunking bases can vary depending on the production method.

With snap-on cover and base with base perforation for direct wall mounting. Change the direction with the fittings and close the trunking ends with end pieces. Service outlet for installing power and data technology. With elastic connection lips for concealing uneven wall surfaces.

Type	Colour	Length mm	Width mm	Height mm	Pack m	Weight kg/100 m	Item no.
SLL 2050 rws	Pure white	2000	50	20	42	41.160	6132212
SLL 2050 cws	Cream	2000	50	20	42	41.160	6132211

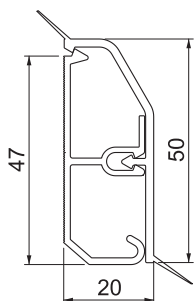



## External corner SLL AE2050

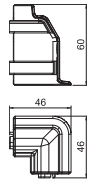

Type	Colour	Length mm	Width mm	Height mm	Pack Piece	Weight kg/100 pc.	Item no.
SLL AE2050 rws	Pure white	46	46	60	10	1.150	6132260
SLL AE2050 cws	Cream	46	46	60	10	1.150	6132261

External corner as a fitting for changing the direction of the skirting trunking.  
External corner for snapping on to the base to conceal cuts.

## Internal corner SLL IE2050

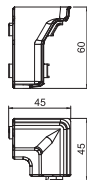

Type	Colour	Length mm	Width mm	Height mm	Pack Piece	Weight kg/100 pc.	Item no.
SLL IE2050 rws	Pure white	45	45	60	10	0.900	6132240
SLL IE2050 cws	Cream	45	45	60	10	0.900	6132241

Internal corner as a fitting for changing the direction of the skirting trunking.  
Internal corner for snapping on to the base to conceal cuts.

## Skirting trunking SLT 2050



Type	Colour	Length mm	Width mm	Height mm	Pack m	Weight kg/100 m	Item no.
SLT 2050 rws	Pure white	2000	50	20	42	45.699	6132218
SLT 2050 cws	Cream	2000	50	20	42	45.854	6132217

SL-T skirting trunking for covered cable routing in internal areas.  
The colour of the trunking bases can vary depending on the production method.

With snap-on cover and base with base perforation for direct wall mounting. Change the direction with the fittings and close the trunking ends with end pieces. Service outlet for installing power and data technology. With carpet strip for a clean finish.

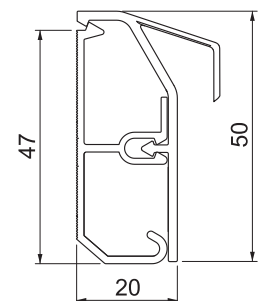

PVC

### End piece SLT ESli2050

Type	Colour	Length mm	Width mm	Height mm	Pack Piece	Weight kg/100 pc.	Item no.
SLT ESli2050 rws	Pure white	30	20	52	10	0.600	6132288
SLT ESli2050 cws	Cream	30	20	52	10	0.600	6132289

End piece (left) as a fitting for the skirting trunking.  
For a clean end to the trunking system. For attaching to the trunking ends.



PVC

### End piece SLT ESre2050

Type	Colour	Length mm	Width mm	Height mm	Pack Piece	Weight kg/100 pc.	Item no.
SLT ESre2050 rws	Pure white	30	20	52	10	0.600	6132302
SLT ESre2050 cws	Cream	30	20	52	10	0.600	6132303

End piece (right) as a fitting for the skirting trunking.  
For a clean end to the trunking system. For attaching to the trunking ends.



## Skirting trunking SL 2070



Type	Colour	Length mm	Width mm	Height mm	Pack m	Weight kg/100 m	Item no.
SL 2070 rws	Pure white	2000	70	20	28	55.007	6132267
SL 2070 cws	Cream	2000	70	20	28	55.010	6132208
SL 2070 lgr	Light grey	2000	70	20	28	55.160	6132269

SL skirting trunking for covered cable routing in internal areas. The colour of the trunking bases can vary depending on the production method.

With snap-on cover and base, with base perforation for direct wall mounting. Change the direction with the fittings and close the trunking ends with end pieces. Service outlet for installing power and data technology.

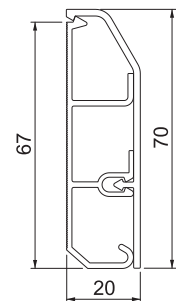

## External corner SL AE2070

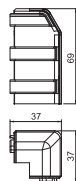

Type	Colour	Length mm	Width mm	Height mm	Pack Piece	Weight kg/100 pc.	Item no.
SL AE2070 rws	Pure white	37	37	69	10	1.300	6132270
SL AE2070 cws	Cream	37	37	69	10	1.300	6132271
SL AE2070 lgr	Light grey	37	37	69	10	1.300	6132272

External corner as a fitting for changing the direction of the skirting trunking.  
External corner for snapping on to the base to conceal cuts.

## Internal corner SL IE2070

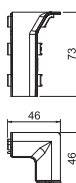

Type	Colour	Length mm	Width mm	Height mm	Pack Piece	Weight kg/100 pc.	Item no.
SL IE2070 rws	Pure white	46	46	73	10	0.700	6132253
SL IE2070 cws	Cream	46	46	73	10	0.700	6132254
SL IE2070 lgr	Light grey	46	46	73	10	0.700	6132255

Internal corner as a fitting for changing the direction of the skirting trunking.  
Internal corner for snapping on to the base to conceal cuts.

PVC

## End piece SL ESli2070

Type	Colour	Length mm	Width mm	Height mm	Pack Piece	Weight kg/100 pc.	Item no.
SL ESli2070 rws	Pure white	22	18	72	10	0.600	6132296
SL ESli2070 cws	Cream	22	18	72	10	0.600	6132297
SL ESli2070 lgr	Light grey	22	18	72	10	0.600	6132298



End piece (left) as a fitting for the skirting trunking.  
For a clean end to the trunking system. For attaching to the trunking ends.

PVC

## End piece SL ESre2070

Type	Colour	Length mm	Width mm	Height mm	Pack Piece	Weight kg/100 pc.	Item no.
SL ESre2070 rws	Pure white	22	18	72	10	0.600	6132281
SL ESre2070 cw	Cream	22	18	72	10	0.600	6132282
SL ESre2070 lgr	Light grey	22	18	72	10	0.600	6132283



End piece (right) as a fitting for the skirting trunking.  
For a clean end to the trunking system. For attaching to the trunking ends.



## Skirting trunking SLL 2070



Type	Colour	Length mm	Width mm	Height mm	Pack m	Weight kg/100 m	Item no.
SLL 2070 rws	Pure white	2000	70	20	42	57.396	6132215
SLL 2070 cws	Cream	2000	70	20	42	57.400	6132214

SL-L skirting trunking for covered cable routing in internal areas. The colour of the trunking bases can vary depending on the production method.

With snap-on cover and base with base perforation for direct wall mounting. Change the direction with the fittings and close the trunking ends with end pieces. Service outlet for installing power and data technology. With elastic connection lips for concealing uneven wall surfaces.

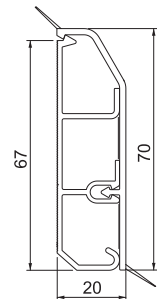

## External corner SLL AE2070

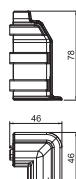

Type	Colour	Length mm	Width mm	Height mm	Pack Piece	Weight kg/100 pc.	Item no.
SLL AE2070 rws	Pure white	78	46	46	10	1.500	6132262
SLL AE2070 cws	Cream	78	46	46	10	1.500	6132263

External corner as a fitting for changing the direction of the skirting trunking.  
External corner for snapping on to the base to conceal cuts.

## Internal corner SLL IE2070

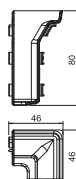

Type	Colour	Length mm	Width mm	Height mm	Pack Piece	Weight kg/100 pc.	Item no.
SLL IE2070 rws	Pure white	46	46	80	10	1.200	6132243
SLL IE2070 cws	Cream	46	46	80	10	1.200	6132244

Internal corner as a fitting for changing the direction of the skirting trunking.  
Internal corner for snapping on to the base to conceal cuts.

PVC

## Skirting trunking SLT 2070



SL-T skirting trunking for covered cable routing in internal areas. The colour of the trunking bases can vary depending on the production method.

With snap-on cover and base with base perforation for direct wall mounting. Change the direction with the fittings and close the trunking ends with end pieces. Service outlet for installing power and data technology. With carpet strip for a clean finish.

Type	Colour	Length mm	Width mm	Height mm	Pack m	Weight kg/100 m	Item no.
SLT 2070 rws	Pure white	2000	70	20	28	61.215	6132222
SLT 2070 cws	Cream	2000	70	20	28	60.480	6132221

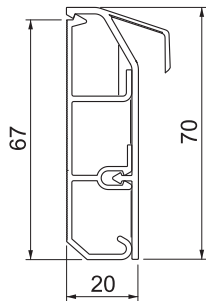

PVC

## End piece SLT ESli2070

Type	Colour	Length mm	Width mm	Height mm	Pack Piece	Weight kg/100 pc.	Item no.
SLT ESli2070 rws	Pure white	30	20	72	10	0.800	6132291
SLT ESli2070 cws	Cream	30	20	72	10	0.800	6132320

End piece (left) as a fitting for the skirting trunking.  
For a clean end to the trunking system. For attaching to the trunking ends.



PVC

## End piece SLT ESre2070

Type	Colour	Length mm	Width mm	Height mm	Pack Piece	Weight kg/100 pc.	Item no.
SLT ESre2070 rws	Pure white	30	20	72	10	0.800	6132305
SLT ESre2070 cws	Cream	30	20	72	10	0.800	6132306

End piece (right) as a fitting for the skirting trunking.  
For a clean end to the trunking system. For attaching to the trunking ends.

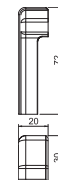

## Skirting trunking SL 20110



Type	Colour	Length mm	Width mm	Height mm	Pack m	Weight kg/100 m	Item no.
SL 20110 rws	Pure white	2000	110	20	18	77.319	6132274

SL skirting trunking for covered cable routing in internal areas. The colour of the trunking bases can vary depending on the production method.

With snap-on cover and base, with base perforation for direct wall mounting. Change the direction with the fittings and close the trunking ends with end pieces. Service outlet for installing power and data technology.

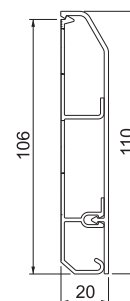

## External corner SL AE20110

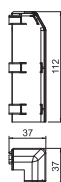

Type	Colour	Length mm	Width mm	Height mm	Pack Piece	Weight kg/100 pc.	Item no.
SL AE20110 rws	Pure white	37	37	112	10	1.800	6132275

External corner as a fitting for changing the direction of the skirting trunking. External corner for snapping on to the base to conceal cuts.

## Internal corner SL IE20110



Type	Colour	Length mm	Width mm	Height mm	Pack Piece	Weight kg/100 pc.	Item no.
SL IE20110 rws	Pure white	46	46	109	10	0.900	6132259

Internal corner as a fitting for changing the direction of the skirting trunking. Internal corner for snapping on to the base to conceal cuts.

PVC

### End piece SL ESli20110

Type	Colour	Length mm	Width mm	Height mm	Pack Piece	Weight kg/100 pc.	Item no.
SL ESli20110 rws	Pure white	22	18	112	10	0.900	6132300

End piece (left) as a fitting for the skirting trunking.  
For a clean end to the trunking system. For attaching to the trunking ends.



PVC

### End piece SL ESre20110

Type	Colour	Length mm	Width mm	Height mm	Pack Piece	Weight kg/100 pc.	Item no.
SL ESre20110 rws	Pure white	22	18	112	10	0.900	6132286

End piece (right) as a fitting for the skirting trunking.  
For a clean end to the trunking system. For attaching to the trunking ends.



## Accessories, skirting trunking

PVC

### Cover SL 2050

Type	Colour	Length mm	Width mm	Height mm	Pack m	Weight kg/100 m	Item no.
SL 2050 OT rws	Pure white	2000	50	20	120	17.271	6132150
SL 2050 OT cws	Cream	2000	20	3	120	17.270	6132308

Cover for skirting trunking.  
As a cover for the trunking base. Snaps on to the trunking base.

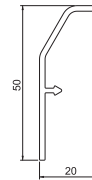

PVC

### Cover SLL 2050

Type	Colour	Length mm	Width mm	Height mm	Pack m	Weight kg/100 m	Item no.
SLL 2050 rws	Pure white	2000	50	20	96	19.660	6132158
SLL 2050 cws	Cream	2000	50	20	96	19.660	6132157

Cover for the skirting trunking.

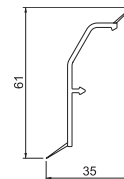

PVC

### Cover SLL 2070

Type	Colour	Length mm	Width mm	Height mm	Pack m	Weight kg/100 m	Item no.
SLL 2070 rws	Pure white	2000	50	70	104	24.880	6132159

Cover for the skirting trunking.

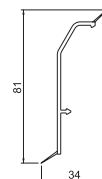

PVC

## Device support SL2GT5070

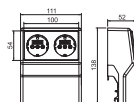

Type	Colour	Length mm	Width mm	Height mm	Pack Piece	Weight kg/100 pc.	Item no.
SL2GT5070 rws	Pure white	52	111	138	1	15.000	6132245
SL2GT5070 cws	Cream	52	111	138	1	14.000	6132246
SL2GT5070 lgr	Light grey	52	111	138	1	14.000	6132247

Device support with pre-terminated double protective contact socket for the skirting trunking in the trunking widths 50 and 70 mm.

Screwed to the wall above the trunking system.

## Device support SL2GTK5070

PVC

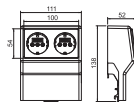

Type	Colour	Length mm	Width mm	Height mm	Pack Piece	Weight kg/100 pc.	Item no.
SL2GTK5070 rws	Pure white	52	111	138	1	15.000	6132179

Device support with pre-terminated double protective contact socket for the skirting trunking in the trunking widths 50 and 70 mm.

Screwed to the wall above the trunking system.

## Device support SL 2GT20110

PVC

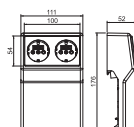

Type	Colour	Length mm	Width mm	Height mm	Pack Piece	Weight kg/100 pc.	Item no.
SL2GT20110 rws	Pure white	52	111	176	1	15.400	6132250

Device support with pre-terminated double protective contact socket for the skirting trunking in the trunking width 110 mm.

Screwed to the wall above the trunking system.

## Device support SL ETler5070

PVC

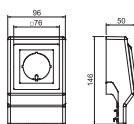

Type	Colour	Length mm	Width mm	Height mm	Pack Piece	Weight kg/100 pc.	Item no.
SL ETler5070 rws	Pure white	50	96	146	1	11.800	6132238
SL ETler5070 cws	Cream	50	96	146	1	11.800	6132239
SL ETler5070 lgr	Light grey	50	96	146	1	11.800	6132237

Empty device support for skirting trunking for the installation of standard devices in support ring and support clamp form with 60 mm fastening track.

For snapping onto the cover of the trunking system.

## Device support SL GTO 50-70

PVC

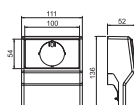

Type	Colour	Length mm	Width mm	Height mm	Pack Piece	Weight kg/100 pc.	Item no.
SL GTO 50-70 rws	Pure white	52	111	136	1	13.300	6132229
SL GTO 50-70 cws	Cream	52	111	136	1	13.300	6132224
SL GTO 50-70 lgr	Light grey	52	111	136	1	13.300	6132223

Empty device support for the SL, SL-L and SL-T skirting trunking systems for the installation of devices in support clamp form (according to DIN 49075) in the trunking widths 50 and 70 mm.

For snapping onto the cover of the trunking system.



PVC

## Device support SL ETler20110

Type	Colour	Length mm	Width mm	Height mm	Pack Piece	Weight kg/100 pc.	Item no.
SL ETler20110rws	Pure white	50	96	184	1	13.400	6132242

Empty device support for skirting trunking for the installation of standard devices in support ring and support clamp form with 60 mm fastening track.  
For snapping onto the cover of the trunking system.

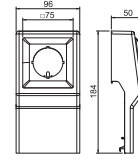

PVC

## Device support SL GTler20110

Type	Colour	Length mm	Width mm	Height mm	Pack Piece	Weight kg/100 pc.	Item no.
SL GTler20110rws	Pure white	52	111	177	1	14.600	6132236

Empty device support for skirting trunking for the installation of devices in support clamp form (according to DIN 49075) in trunking width 110 mm.  
For snapping onto the cover of the trunking system.

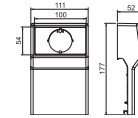

PC / ABS

## Blind cover SL BL blind

Type	Colour	Length mm	Width mm	Height mm	Pack Piece	Weight kg/100 pc.	Item no.
SL BL blind rws	Pure white	54	100	7	1	1.950	6132199
SL BL blind cws	Cream	54	100	7	1	1.950	6132252

Blanking cover for closing the service outlet.

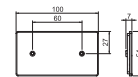

## Antenna socket panel SL BL ANT

Type	Colour	Length mm	Width mm	Height mm	Pack Piece	Weight kg/100 pc.	Item no.
SL BL ANT rws	Pure white	100	54	5	1	2.100	6132258
SL BL ANT cws	Cream	100	54	5	1	2.100	6132195

Antenna cover for installing antenna sockets in the service outlet of the skirting trunking. Cover for antenna socket  
For side closing of the service outlet.

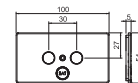

PVC

## Side closure, device tank SL GTSA5070

Type	Colour	Length mm	Width mm	Height mm	Pack Piece	Weight kg/100 pc.	Item no.
SL GTSA5070 rws	Pure white	4	27	72	10	0.800	6132234
SL GTSA5070 cws	Cream	4	27	72	10	0.800	6132197

Side cover panel for side enclosing of the service outlet.

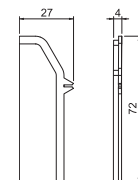

## Coupling SL KUP2050

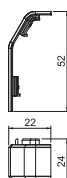

Type	Colour	Length mm	Width mm	Height mm	Pack Piece	Weight kg/100 pc.	Item no.
SL KUP2050 rws	Pure white	24	22	52	10	0.400	6132225
SL KUP2050 cws	Cream	24	22	52	10	0.400	6132226

Trunking coupling for SL, SL-L and SL-T skirting trunking. For connecting the interfaces of the individual trunking bases.

Easily attached using moulded snap-in hooks.

## Coupling SL KUP2070

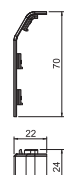

Type	Colour	Length mm	Width mm	Height mm	Pack Piece	Weight kg/100 pc.	Item no.
SL KUP2070 rws	Pure white	24	22	70	10	0.500	6132230
SL KUP2070 cws	Cream	24	22	70	10	0.500	6132231
SL KUP2070 lgr	Light grey	24	22	70	10	0.500	6132232

Trunking coupling for SL, SL-L and SL-T skirting trunking. For connecting the interfaces of the individual trunking bases.

Easily attached using moulded snap-in hooks.

## Coupling SL KUP20110



Type	Colour	Length mm	Width mm	Height mm	Pack Piece	Weight kg/100 pc.	Item no.
SL KUP20110 rws	Pure white	24	22	110	10	0.600	6132235

Trunking coupling for SL, SL-L and SL-T skirting trunking. For connecting the interfaces of the individual trunking bases.

Easily attached using moulded snap-in hooks.

## ECK corner trunking

### ECK 35 corner trunking, trunking width 35

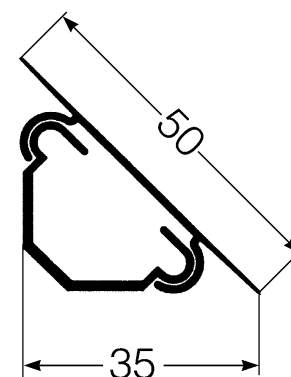

Type	Colour	Length mm	Width mm	Height mm	Pack m	Weight kg/100 m	Item no.
ECK 3535 rws	Pure white	2000	35	35	60	18.832	6131155
ECK 3535 rws	Pure white	2500	35	35	75	20.067	6131154
ECK 3535 cws	Cream	2000	35	35	60	18.832	6131153
ECK 3535 cws	Cream	2500	35	35	75	20.067	6131152

Corner trunking for vertical/horizontal cable routing in indoor corner areas.

Trunking base with base perforation for direct mounting on the wall.

PVC

## Transition piece, TRI C 35-16 to SL 20/50

Type	Colour	Length mm	Width mm	Height mm	Pack Piece	Weight kg/100 pc.	Item no.
<b>TRI C 35-50 rws</b>	Pure white	95	60	60	10	3.000	<b>6131185</b>

Transition piece for transition from corner trunking 35 to SL 20/50 skirting trunking.



PVC

## End piece TRI ES350350

Type	Colour	Length mm	Width mm	Height mm	Pack Piece	Weight kg/100 pc.	Item no.
<b>TRI ES350350 rws</b>	Pure white	55	35	25	10	0.450	<b>6131179</b>

End piece as a fitting for the RAUTRIGO corner trunking.  
For a clean end to the trunking system.



PVC

## Transition piece TRI C 35-16

Type	Colour	Length mm	Width mm	Height mm	Pack Piece	Weight kg/100 pc.	Item no.
<b>TRI C 35-16 rws</b>	Pure white	60	55	40	10	1.200	<b>6131182</b>

Transition piece for transition from corner trunking 35 to MKS 1616.



## ECK 50 corner trunking, trunking width 50

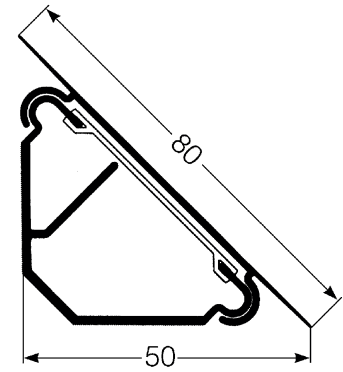

Type	Colour	Length mm	Width mm	Height mm	Pack m	Weight kg/100 m	Item no.
ECK 5050 rws	Pure white	2500	80	50	45	42.844	6131165
ECK 5050 rws	Pure white	2000	80	50	30	42.844	6131164
ECK 5050 cws	Cream	2500	80	50	45	42.844	6131162
ECK 5050 cws	Cream	2000	80	50	30	42.850	6131163

Corner trunking for vertical/horizontal cable routing in indoor corner areas.

Trunking base with base perforation for direct mounting on the wall.

## Internal corner TRI IE500500



Type	Colour	Length mm	Width mm	Height mm	Pack Piece	Weight kg/100 pc.	Item no.
TRI IE5050 rws	Pure white	85	90	90	10	2.000	6131172

Internal corner as a fitting for changing the direction of the 50 corner trunking.

PVC

# Skirting trunking RD 40105



Base of the RAUDUO trunking system with 2 individual, thermally separated chambers for joint laying of electrical cables and heating pipes. With locking function for accommodating the trunking covers. The colour of the trunking bases can vary depending on the production method.

Lower chamber for accommodating electrical cables with extruded partition for the separate laying of high- and low-voltage current. Standard base perforation.

Type	Length mm	Width mm	Height mm	Pack m	Weight kg/100 m	Item no.
RD 40105 natur	2000	105	40	24	80.000	6132205

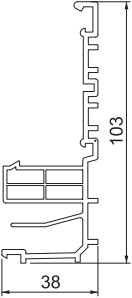

## Trunking cover RD OT40105

PVC



Type	Colour	Length mm	Width mm	Height mm	Pack m	Weight kg/100 m	Item no.
RD OT40105 rws	Pure white	2000	105	40	24	46.341	6132160
RD OT40105 cws	Cream	2000	105	40	24	46.341	6132161

Cover for RAUDUO trunking.  
For snapping onto the base of the trunking system.

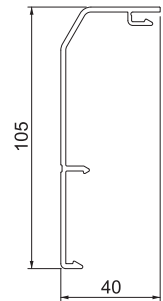

## Trunking cover RDL OT40105

PVC



Type	Colour	Length mm	Width mm	Height mm	Pack m	Weight kg/100 m	Item no.
RDL OT40105 rws	Pure white	2000	120	40	24	48.842	6132264
RDL OT40105 cws	Cream	2000	120	40	24	48.842	6132190

Cover for RAUDUO trunking.  
For snapping onto the cover of the trunking system. With sealing lip to protect against moisture and to compensate for minor wall unevenness.

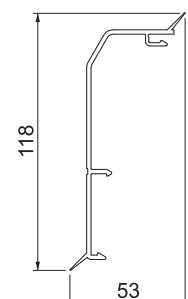



PVC

### External corner RD AE40105

Type	Colour	Length mm	Width mm	Height mm	Pack Piece	Weight kg/100 pc.	Item no.
RD AE40105 rws	Pure white	107	75	75	10	3.400	6132165
RD AE40105 cws	Cream	107	75	75	10	3.400	6132166

External corner as a fitting for changing the direction of the RAUDUO trunking system.  
Can be attached using moulded snap-in hooks.

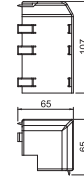

PVC

### Internal corner RD IE40105

Type	Colour	Length mm	Width mm	Height mm	Pack Piece	Weight kg/100 pc.	Item no.
RD IE40105 rws	Pure white	107	75	75	1	2.400	6132280
RD IE40105 cws	Cream	107	75	75	10	2.400	6132164

Internal corner as a fitting for changing the direction of the RAUDUO trunking system.  
Can be attached using moulded snap-in hooks.

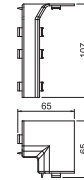

PVC

### End piece RD ESL40105

Type	Colour	Length mm	Width mm	Height mm	Pack Piece	Weight kg/100 pc.	Item no.
RD ESL40105 rws	Pure white	19	106	42	10	1.400	6132168
RD ESL40105 cws	Cream	19	106	42	10	1.400	6132169

End piece (left) as a fitting for the RAUDUO trunking system.  
For a clean end to the trunking system. For attaching to the trunking ends.



PVC

### End piece RD ESR40105

Type	Colour	Length mm	Width mm	Height mm	Pack Piece	Weight kg/100 pc.	Item no.
RD ESR40105 rws	Pure white	19	106	42	10	1.400	6132285
RD ESR40105 cws	Cream	19	106	42	10	1.400	6132167

End piece (right) as a fitting for the RAUDUO trunking system.  
For a clean end to the trunking system. For attaching to the trunking ends.



## Accessories, RAUDUO skirting trunking

PA

### Heating pipe support RD DUO HRT 2 20

Type	Length mm	Width mm	Height mm	Pack Piece	Weight kg/100 pc.	Item no.
RD DUO HRT 2 20	52	32	40	10	1.500	6132170

Heating pipe support for guiding a universal pipe in the RAUDUO trunking system.

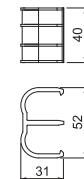

PVC

## Device tank RD GT40105, double

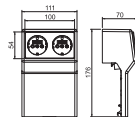

Type	Colour	Length mm	Width mm	Height mm	Pack Piece	Weight kg/100 pc.	Item no.
RD 2GT40105 rws	Pure white	62	112	175	1	17.400	6132171
RD 2GT40105 cws	Cream	62	112	175	1	17.400	6132172

Service outlet for installing devices with support clamps for the RAUDUO trunking system. Universally equippable.  
For snapping onto the cover of the trunking system. Universally equippable.

PVC

## Device tank RD GT40105, single

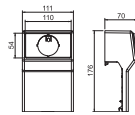

Type	Colour	Length mm	Width mm	Height mm	Pack Piece	Weight kg/100 pc.	Item no.
RD GT40105 rws	Pure white	62	112	175	1	18.000	6132173
RD GT40105 cws	Cream	62	112	175	1	15.100	6132174

Device support for the RAUDUO skirting trunking system for the installation of devices in support clamp form (according to DIN 49075).  
For snapping onto the cover of the trunking system. Not equipped.

PS

## Insulating foam RD DUO ISO

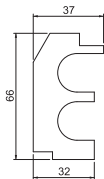
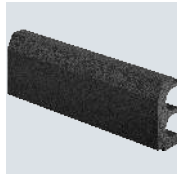

Type	Length mm	Width mm	Height mm	Pack Piece	Weight kg/100 pc.	Item no.
RD DUO ISO	200	66	38	1	0.850	6132175

Insulating foam for the RAUDUO trunking system.

PVC

## Trunking coupling RD Kup40105

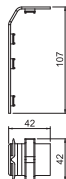

Type	Colour	Length mm	Width mm	Height mm	Pack Piece	Weight kg/100 pc.	Item no.
RD KUP40105 rws	Pure white	107	42	42	10	1.300	6132176
RD KUP40105 cws	Cream	107	42	42	10	1.300	6132177

Trunking coupling for connecting the skirting trunking.  
Easily attached using moulded snap-in hooks.

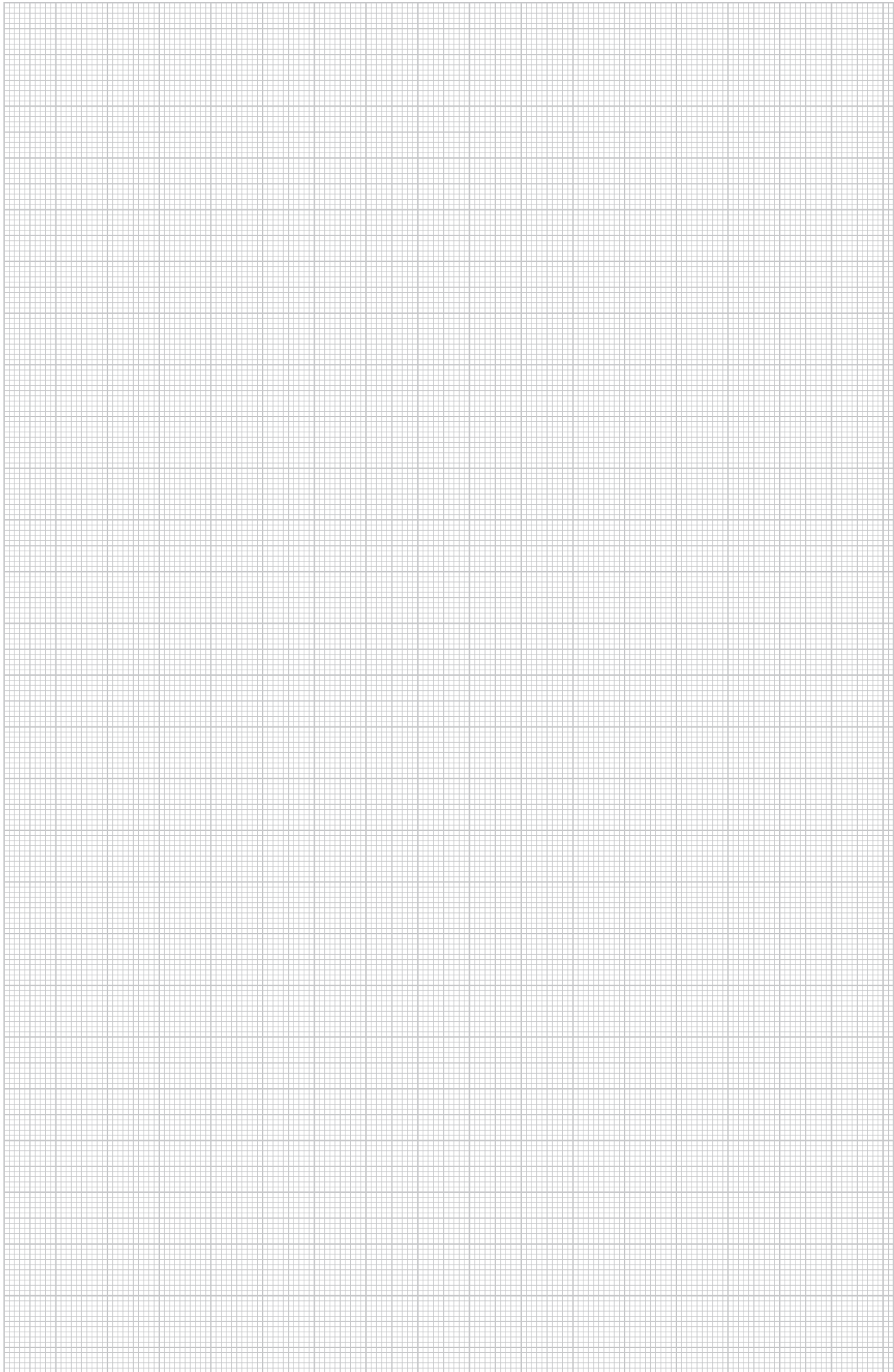

**OBO Bettermann Vertrieb Deutschland GmbH Co. KG**

Langer Brauck 25  
58640 Iserlohn  
GERMANY

**Customer Service**

Tel.: +49 23 73 89 - 17 00  
Fax: +49 23 73 89 - 12 38  
[export@obo.de](mailto:export@obo.de)

[www.obo-bettermann.com](http://www.obo-bettermann.com)

---

**Building Connections**

